

MARKER

THE MAGAZINE FOR THE SHEET
METAL WORKING INDUSTRY
2012 | 2013

- New site: Technical Center Landshut
- AMADA at EuroBLECH 2012
- Fiber laser system in productive operation

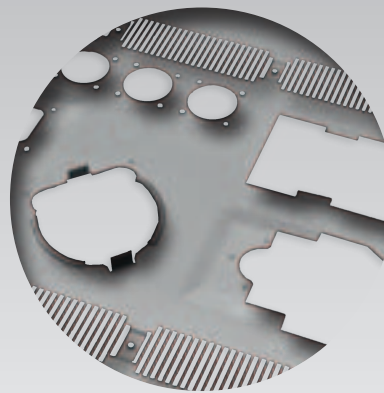

MARKER

THE MAGAZINE FOR THE SHEET
METAL WORKING INDUSTRY
2012 | 2013



Dear readers,

Great events lie ahead. And one of these is very definitely our industry's biannual flagship trade fair, the EuroBLECH in Hanover. At AMADA, we are already ready and waiting and have prepared a truly spectacular feast of innovation for you: We will present no fewer than ten systems representing the fields of bending, punching, lasers and welding – including combined processes, software and automation – in live operation during this industry event. What

you will experience is the complete spectrum of innovative sheet metal working. I should like to invite you: Take the tour of our centers of technological expertise and be prepared to be astonished by the productivity and efficiency benefits that our products can offer you! AMADA is close to you. That means that our technologies can be discovered not just at EuroBLECH but also whenever you want at one of our sites throughout Europe. The most recent of these is the

Technical Center Landshut that will open its doors to visitors in early 2013. The importance of this site, from which you, too, can benefit, for AMADA is explained in the current edition of MARKER.

Yours sincerely,

*Yasuhiro Kawashita,
General Manager of
AMADA GmbH*

WHAT'S HAPPENING	
AMADA at EuroBLECH 2012	4
INTERVIEW	
Christof Behrendt on AMADA's strategy	6
INTRODUCING	
Technical Center Landshut	10
INNOVATION	
LASBEND AJ combination machine	14
FLC-3015 AJ fiber laser cutting machine	16
FLW series fiber laser welding machines	18
FLCP-2515 AJ machining center	20
ACIES-2515 T punch-laser combination system	22
EM-3612 ZRT turret punch press	24
HG series hybrid presses	26
HG-1003 ATC automated hybrid press	28
EG-6013 servoelectric press brake	30
EG-6013 AR automated bending cell	32
APPLICATIONS	
BVD GmbH	34
DATES + FACTS	
Service, Dialogue, Events	38

Highly demanding components such as this are manufactured on AMADA's machines and systems. AMADA will be presenting the entire spectrum of modern sheet metal working at EuroBLECH 2012.

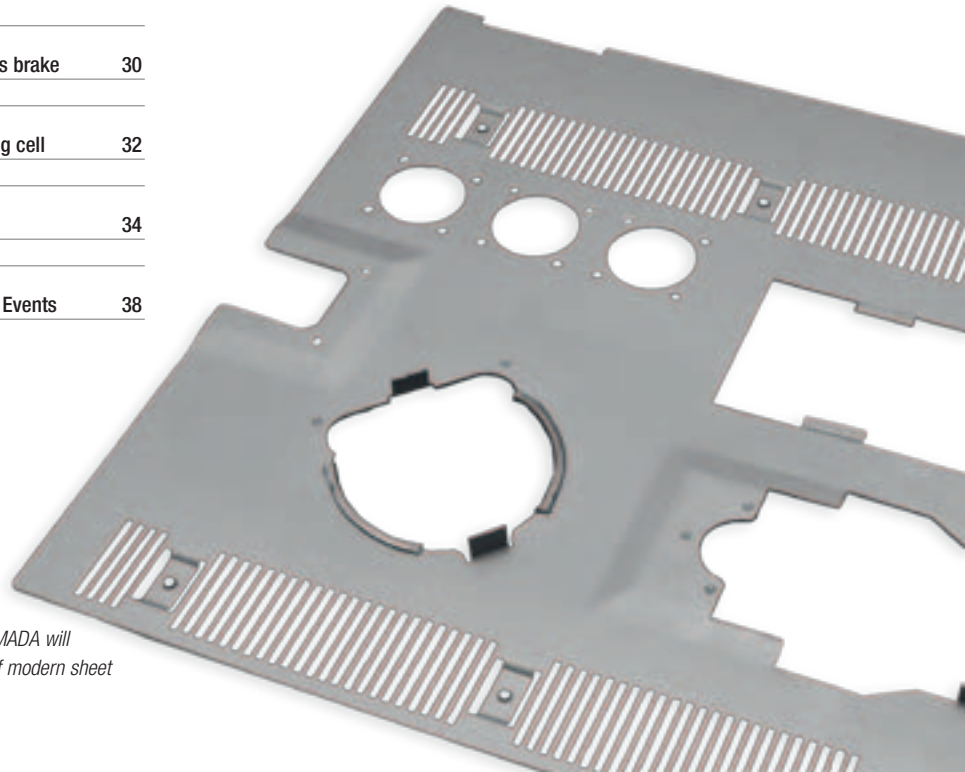

AMADA at EuroBLECH 2012

A feast on innovation

It is the undisputed international highlight for the sheet metal working sector: The EuroBLECH trade fair which is held every two years in Hanover. In 2012, it will be welcoming visitors during the period October 23 to 27. At booths D06 and F06 in Hall 12, AMADA will be presenting more new developments than ever before at a single EuroBLECH.



The design of the AMADA booth is based on the architecture of the three international Solution Centers, the most recent of which, in Haan near Düsseldorf, is also the headquarters of AMADA GmbH. In a spacious, modern environment of approximately 2,000 square meters, AMADA will demonstrate a range of fascinating new developments for modern sheet metal working at the Hanover trade fair.

Fiber laser – a technological highlight

All the machines on view will certainly be production-ready. And every one of them rep-

resents a further development to an existing solution or a completely new innovation. Visitors will therefore not see anything that is already familiar to them – a veritable feast of innovation!

At EuroBLECH, AMADA will unveil a complete overview of its current technologies including automation, software and tools. Two years ago, AMADA revealed the possibilities of laser cutting for the first time with its innovative fiber laser system. AMADA has greatly extended this sector of its technology, with the result that the four machines on display at EuroBLECH 2012 will make it a focal point

of the trade fair. But, of course, conventional CO₂ laser technology as well as the sectors of bending, punching and combination technologies will all be represented by the latest generation of systems at the AMADA booth.

AMADA brings trends to life

EuroBLECH is the world's largest specialist trade fair for the sheet metal working industry. Approximately 1,400 exhibitors from 40 countries are expected at the Hanover exhibition site in the autumn. The trade fair is the ideal marketplace for specialists from all parts of the



System Automation



Laser



Punching



Software



Shearing



Bending



Welding

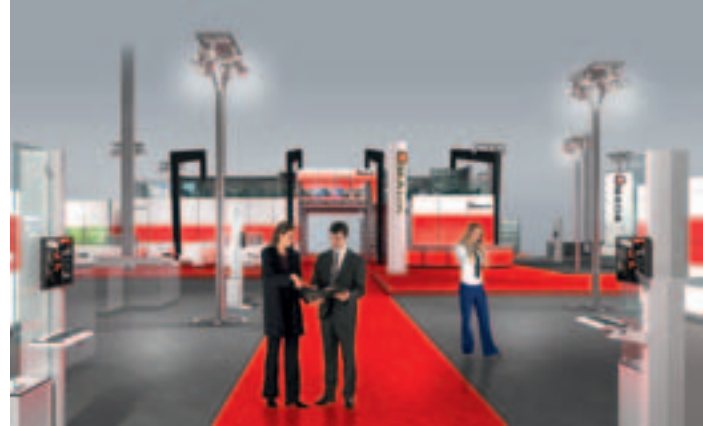

world to discover the machines and tools they need and identify intelligent solutions for their companies and their competitiveness. Industry professionals know the value of this showcase: EuroBLECH 2010 welcomed more than 60,000 visitors. In 2012, EuroBLECH will focus on efficient technologies, environmentally responsible production processes and the intelligent use of materials. All these trends can be experienced live at the AMADA booth. ●

The design of the AMADA booth reflects the architecture of the Solution Center. AMADA will inform visitors about state-of-the-art sheet metal working over an area of approximately 2,000 square meters.



The World's No.1

I N F O

EuroBLECH 2012

22nd International Sheet Metal Working Technology Exhibition
Hanover Exhibition Site on October 23 – 27, 2012

AMADA in Hall 12, Booths D06 and F06

Opening hours: Tuesday to Friday 9.00 – 18.00
Saturday 9.00 – 15.00

Organized by: Mack Brooks Exhibitions
Infoline: +44 1727 814 400
www.euroblech.com

Christof Behrendt on AMADA's new strategic orientation

Customer and market proximity drive our strategy



Christof Behrendt, Director Sales and Marketing at AMADA GmbH.

To be more than just a machine supplier but also a partner that advises and supports its customers and learns from their needs – that is one very important component of the AMADA corporate philosophy. Christof Behrendt, Director Sales and Marketing at AMADA GmbH, explains how the company achieves this goal and what implications it has for the policies pursued at its European sites.

MARKER: Mr Behrendt, what new strategic developments can currently be seen at AMADA in Europe and, most importantly, what do they mean for customers?

Christof Behrendt: The construction of our new Technical Center Landshut is particularly significant in this regard. We devote an in-depth article in MARKER to this decisive step so I shall not dwell on it for too long here. For us, our new sales branch in Landshut and, in particular, its proximity to AMADA Advanced Technology GmbH, which

is responsible for Research and Development within the Group, represents a further step toward our goal of gaining ever greater proximity to important markets. Possessing a broad base, including at the level of our European sites, improves our ability to recognize trends early, actively help to shape them, and tune into our customers' requirements for new developments practically as they emerge.

MARKER: It might well now be assumed that research and development operations have



The European market is the source of important technological trends that have a major impact on global standards.

been concentrated in Japan where AMADA's largest production facilities are also located ...

market alone but instead flow into all AMADA products worldwide. This early recognition of market trends represents a strategic path

that AMADA has been pursuing for quite some time. Indeed, our current product portfolio is the result of this approach ▶

Christof Behrendt: The AMADA Group thinks globally. The link between development and production is not a one-way street but, to continue the metaphor, a highway on which traffic can move in both directions. That is why activities at our new Landshut site are also clearly structured in a way that means that the trends we identify here do not lead to further developments for the European



A partnership-based approach in dialogue with the customer is a key part of AMADA's strategy.



Renewable energies: An outstanding example of a newly emerging growth sector.

► which can be summed up as: We listen to our customers' needs.

MARKER: What technological trends are you thinking of?

Christof Behrendt: The range of machines that we will present at EuroBLECH 2012 is a reflection of the main trends that are important for industrial sheet metal working today and that will continue to grow in significance in the future. Foremost among these is quite clearly the further development

of fiber laser technology for an extremely diverse range of 2D and 3D applications. In addition, we are now witnessing increasing demands in the field of bending automation. The need to minimize non-productive setup times is a crucial challenge facing our customers. At the same time as consumer products are becoming increasingly diversified, the production runs of the sheet metal assemblies they contain are becoming ever shorter. Fabricators face the challenge of having to speed these small volumes through their production shops in ever shorter periods

in order to manufacture economically. As a supplier of combined machine and automation solutions, we help our customers ensure that the non-productive setup times do not constantly eat away at productive machining times. Thanks to the feedback we receive from users, we are able to help them overcome these challenges through our continued development activities. Technological trends of this type are extremely widespread in the European market. That is why this market is an enormously important indicator for the AMADA Group, which has its

head office in Japan, and is a region where the Group's presence is constantly being strengthened. European manufacturing standards are a very clear part of the Group's international focus.

MARKER: The European market has only just emerged from a severe crisis. How was AMADA able to protect itself from its repercussions?

Christof Behrendt: Anticyclical activity is a part of the AMADA strategy that proves its value at such times. It was precisely during the crisis that AMADA completely reconstructed one of its European sites through the inauguration of the Solution Center in Haan and in this way developed the capacities needed for successful cooperation with its customers once the crisis had passed. The construction of the

Technical Center Landshut represents another logical step undertaken to increase proximity to customers. The ability to undertake an anticyclical investment policy as the AMADA Group has done is far from self-evident. However, the possession of a worldwide presence such as AMADA enjoys represents a good basis for warding off the effects of economic weaknesses in individual regions. We pass on the benefits of this approach to our customers – through

technological developments and a strong presence wherever our customers need us. And one thing should not be forgotten: While certain sectors of industry were particularly hard hit by the economic crisis, there are a number of new growth areas in which sheet metal working has a part to play. I am thinking in particular of the renewable energies segment and the systems needed for the production of renewables. ●



The construction of the AMADA Solution Center in Haan reflects the Group's anticyclical approach. A further step: the Technical Center Landshut.

New AMADA Technical Center Landshut

Additional site to support the new strategic orientation

In April 2013, AMADA GmbH will move into a new additional premises in Eching in the district of Landshut, 65 kilometers from Munich city center. In addition to the Landshut Technical Center in Eching, which will be used for demonstration and consulting purposes, a new Research and Development Center is also being constructed on the same site. In this way, the AMADA Group will be able to further expand its position in the important European market.

The overall concept of the Technical Center Landshut forms part of AMADA's objective of providing customers with optimized, consistent support in their desire to remain innovative, competitive and economically efficient in the future. At the Technical Center Landshut, the focus lies not just on the presentation of the various technologies but also on a cross-

solution offering consisting of analysis and consulting services. In this way, users will benefit from exhaustive information on the latest developments in the sheet metal working sector. For AMADA, the decision to construct an additional site in Southern Germany is of strategic significance since it extends the network of existing branches in Europe at



Technical Center Landshut: Modern architecture integrated in the surrounding natural environment.

There has been a show room in Landshut for AMADA's existing and prospective customers since June 2012.



which visitors can experience AMADA's technologies at first hand and in live operation.

Customer proximity

Proximity to the customer is an important part of AMADA's corporate philosophy that ensures that users benefit from optimized machine solutions. From the geographical point of view, Eching in the district of

Landshut is optimally situated for market activities in Southern Germany, Austria and the neighboring countries of Central and Eastern Europe. The new AMADA site is located practically at the center of a number of car production plants which in turn act as a magnet for companies in the automotive supply industry. The mechanical engineering and electronics industries also have a strong presence in the region.

Support for customers in Central and Eastern European countries such as the Czech Republic, Slovakia, Poland or Hungary continues to be provided by AMADA's proven sales partners. With the opening of the Technical Center Landshut, AMADA is also extending the capacities it can offer these partners in terms of practical sheet metal working applications and in this way is extending the services available from the Solution Center in Haan. ►



► Ideal R&D location

The high customer density in Southern Germany, together with the accompanying high levels of innovation, offers many opportunities to optimize and accelerate development activities. As a result, production solutions and developments meeting European standards can be taken over as global standards. This was an important reason motivating the decision to construct a second building for

research and development at the Eching site. "This Center is now home to AMADA Advanced Technology GmbH. The Research and Development Center forms an important interface between the global market and the European market," explains Ichiro Egashira, Managing Director of AMADA Advanced Technology GmbH in Landshut. In order to launch these activities in Southern Germany as rapidly as possible, AMADA opened a show room in a rented

building at Ottostraße 27 in Landshut itself on June 1st, 2012. Here it is possible to conduct time and feasibility studies as well as live machine presentations. The response to the start-up of activities at the Landshut site has been extremely positive. Since opening the show room, AMADA has welcomed a large number of visitors and the strengthening of the company's presence in Southern Germany has been greeted with considerable enthusiasm. At the



System Automation



Laser



Punching



Software



Shearing



Bending



Welding



A M A D A T E C H N I C A L C E N T E R L A N D S H U T

Total investment volume	approx. 16 mill. euros
Size of site	approx. 25,000 sqm
Number of buildings	2: Technical Center Landshut (TCL), Research and Development Center (R&D)
Gross floor area	TCL: 3,050 qm R&D: 1,840 qm
Display area	Show Room in TCL: 1,070 sqm
Green areas	more than 10,000 sqm
Planned planting	more than 70 trees

same time, considerable efforts are now being made to extend the team of experts at the Eching site. New employees are being recruited for sales, application technology and research and development

activities. By the time the Landshut Technical Center is opened in early 2013, this committed expert workforce in Southern Germany will have reached its provisional level of 30 employees.

Respect for nature and the environment

The construction site for the Landshut Technical Center and Research and Development Center is easily accessible by motorway close to Munich international airport. It borders on a business park, covers approximately 25,000 square meters and is surrounded by greenery and water. Respect and responsibility for nature and the environment are an integral part of the AMADA philosophy. Therefore they clearly played an important role in the development of the new Technical Center. The site will boast a green area of more than 10,000 square meters. More than 70 trees will be planted on this area. Furthermore, the building will make a concrete contribution to reducing resource consumption since the energy requirement for heating and air conditioning will be covered 100 percent by geothermal sources. ●

LASBEND AJ combination machine

Harmonized technologies for the most demanding requirements

The new LASBEND AJ machining center stands for innovative bending, forming, thread cutting and laser technology – all packaged within a functional design. It represents the perfect interaction of different components through which AMADA has created a new dimension in efficiency and precision.

The LASBEND AJ provides top-quality combination technology for the fast production of prototypes as well as for the manufacture of individual parts and small runs within a self-contained production process. The AJ vertical fiber laser

with output of 2,000 Watt and rotary bending unit guarantee top precision while simultaneously permitting extremely fast machining times. "In addition, small, complex specialty workpieces that it would be all but impossible

to manufacture using conventional technologies can be machined accurately and reliably thanks to the presence of handling robots," explains Michael Groß, Product Manager at AMADA. The LASBEND AJ provides an integrated combination of laser cutting, forming, thread cutting and bending capabilities. During the first step, the fiber laser cuts clusters which are guided vertically through the machine during subsequent processing. For the first time, the fiber laser also makes it

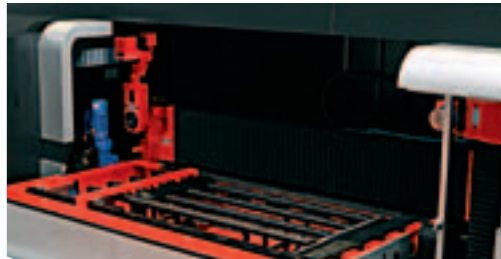
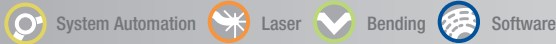

The optimized CAM software and AMNC control unit make the machine convenient and easy to operate.

Innovative bending, forming, thread cutting and laser technology to meet the highest standards.



possible to machine difficult-to-cut materials such as copper or brass. The particularly secure fixing of the workpieces during the cutting process forms the basis for high-precision production which, in turn, results in reduced manufacturing costs.

Optimized combination technology

Alongside the AMADA fiber laser, the unique bending unit is not only optimally equipped

but also boasts an innovative extension: During the bending process, the newly installed BI-J angle measurement system measures the bending angle and is able to adjust bending control if required. This guarantees the absolute dimensional accuracy of the manufactured part. The bending unit possesses a total of ten controlled axes which make it possible to perform even the most complex bending operations without the use of a backgauge. The suspended clusters is guided vertically through the bending tools which travel to the part and shape it by means of

rotary movements. The automatic tool changer present in the bending module is able to change a large number of tools automatically and thus makes it possible to process complex workpieces without the need for manual intervention. The fact that the bending unit is able to bend several different parts from the same sheet brings about considerable time savings. The increased bending speed also contributes greatly to the economic efficiency of the new combination machine. At the same time, the optimized CAM software and AMNC control unit ensure ease of operation. ●



LASBEND AJ: Efficiency and precision.

T E C H N I C A L D A T A

LASBEND AJ

Fiber laser

Maximum sheet size	2,500 × 1,250 mm
Material thickness	0.3 – 4.0 mm
Laser output	2,000 W
Number of controlled axes	7

Rotary bending unit

Material thickness	0.8 – 4.0 mm
Press force	200 kN
Press beam length	4 – 400 mm
Number of controlled axes	10

FLC-3015 AJ laser cutting machine

Fast, precise, efficient

The FLC-3015 AJ laser cutting machine combines the proven design of the F1 series with AMADA's fiber laser technology. As a result, the FLC-3015 AJ not only sets new standards in terms of speed and precision but is also the most economical machine solution available for the mid-range segment.

At EuroBLECH 2012, AMADA will present the FLC-3015 AJ as an example of a versatile, highly efficient laser cutting machine. The use of the AJ fiber laser, which has an output power of 2,000 Watts, permits exceptional machining speeds

while simultaneously achieving high-precision results. Thin sheets and difficult-to-cut materials such as copper, aluminum or titanium can be machined quickly, reliably and pre-

cisely. Considerably shortened manufacturing times coupled with the fiber laser's excellent energy consumption figures ensure considerable cost savings while also preserving resources. In combination with high-performance control technology, the highly dynamic, wear-free and practically maintenance-free linear drive guarantees both outstanding cutting accuracy and optimum product quality. Thus high-precision linear measuring scales installed in a closed



System Automation



Laser



Software

The FLC-3015 AJ excels through its speed, precision and energy efficiency.

*AMADA fiber laser technology
for high-precision workpieces.*

control circuit ensure optimum dimensional accuracy at maximum operating speed.

Versatile machine layout

The FLC-3015 AJ has a working area of 3,000 mm × 1,500 mm and the table is able to accept sheets of a weight of up to 920 kg. In the same way as the LC-F1 NT series, this system possess a unique machine frame whose structure and low center of gravity

mean that there is no need for any special machine base. Even at top machining speeds, the distortion-resistant, low-vibration cast machine bed guarantees that manufacturing operations are conducted under optimum conditions.

The FLC-3015 AJ is an extremely versatile machine which, when coupled with the appropriate automation technology, can perform complex tasks for long periods of time without the need for manual intervention.

Another advantage of this machine lies in its layout which can be individually adapted to meet the needs of different users and permits the variable assembly of the machine components. As a result, the machine is compact, always provides optimum access and permits the shortest possible travel paths even during multi-machine operation. The use of the proven AMNC-PC control unit guarantees a high level of safety and ergonomic efficiency thanks to its great ease of operation. ●

T E C H N I C A L D A T A

FLC-3015 AJ	
Fiber laser output	2,000 W
Working area	3,000 × 1,500 mm
X/Y/Z drives	linear
Travel speed X/Y both axes simultaneously	169 m/min

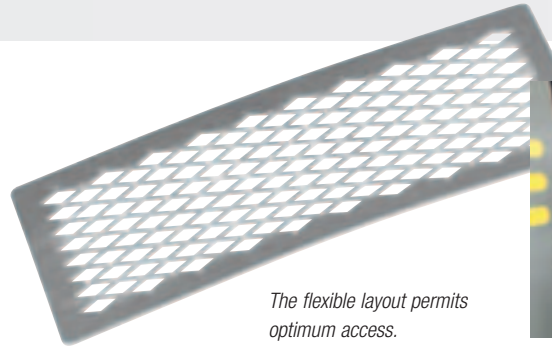

*The flexible layout permits
optimum access.*



FLW series

Welding with the fiber laser

Succeeding in production tasks that were previously impossible or could only be achieved with great difficulty – that is where fiber laser technology excels. In the welding field, AMADA is now giving its customers access to a new form of process expertise in the form of its FLW series.

Above all others, there is one incomparable advantage that makes fiber laser technology stand out: It permits the largely unproblematic machining of demanding materials such as copper, brass and titanium. Following the outstanding success of this capability in the field of laser

cutting, AMADA has now extended it to the world of laser welding with the launch of its new FLW series. And compared with pure cutting operations, when used for welding, this technology offers another major plus that will open up further interesting areas of application:

Fiber laser welding technology also permits the machining of material combinations that previously posed an enormous challenge to users. Thus, for example, it is possible to weld together copper and stainless steel sheet components, which are characterized by very different melting points, to form assemblies. What is more, the use of fiber

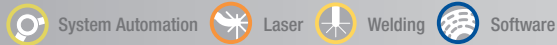

The system produces perfect weld seams.

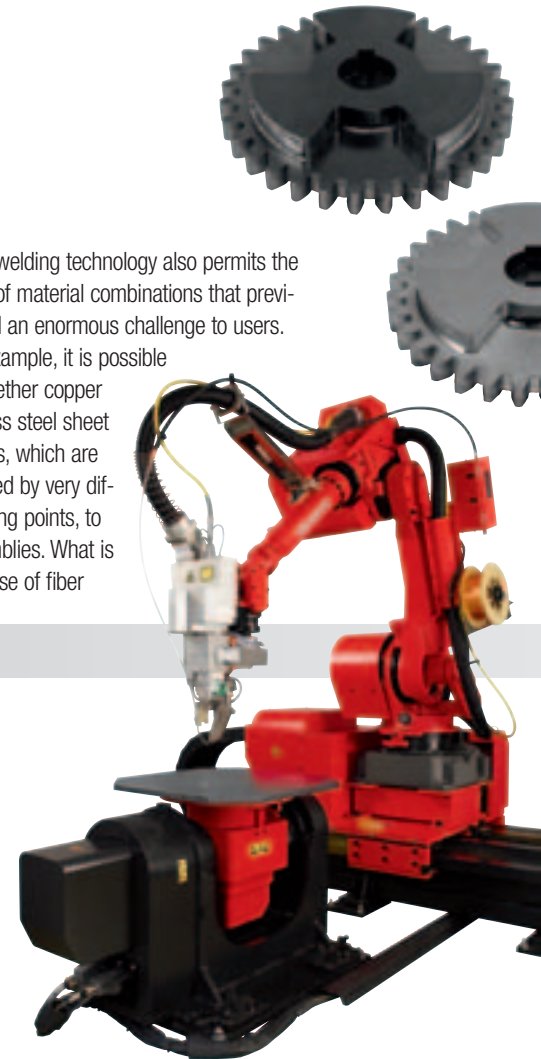



The fiber laser can weld demanding materials.

laser technology is also beneficial when machining materials with comparatively high reflectance values. This is also the case of copper and brass, for example.

Rotating lens for optimum machining

One special feature of the AMADA FLW series is the optical assembly which is equipped with a patented rotating lens. This means that the laser beam is no longer aligned with a

specific point on the target; instead it circles within a small area. This makes it possible to bridge larger as well as uneven gap sizes and a clean, even welding process is guaranteed. The heat input into the material is also optimized. The result is precisely defined weld edges with almost no deposits of material. This capability contributes to the great economic efficiency of the FLW series by minimizing the need for retouching operations at the workpiece or even eliminating them. The FLW series is particularly user friendly due to its specially developed software solu-

tion combined with a high-resolution camera system. During the setup phase, this is used to position the welding head and define the precise weld trajectory. Users can intuitively develop welding programs ready for operation faster than before and the time taken to set up the system is reduced. AMADA will be presenting a machine from its FLW series live for the first time at EuroBLECH 2012. The overall series has been conceived as a modular system and covers a wide performance range. ●



Thanks to the specially developed software, the robot can be set up quickly and easily.

T E C H N I C A L D A T A	
FLW series	
Fiber laser	
Laser output	1,000 – 6,000 W
Robot	
Travel speed	60 m/min
Repeat accuracy of positioning	± 0.1 mm
Working area of vertical axis	± 720°
Working area of tilting axis	± 90°

FLCP-2515 AJ punch-laser machining center

The perfect interaction

Innovative processes from the worlds of punching and laser technology combined to offer great versatility and high performance— the new FLCP-2515 AJ combination machine with AMADA's own 2 kW fiber laser makes this possible. The machine stands for faster machining times coupled with reduced energy requirements and guarantees top-quality results.

With the new FLCP-2515 AJ, AMADA has succeeded in developing an integrated combination of laser cutting and punching. AMADA's inhouse AJ fiber laser, which provides output of 2,000 Watts, is used in order to achieve a perfect interaction between

machine, controller and resonator. Compared to conventional systems, the significantly higher cutting speed and reduced energy requirement, in particular, help bring about considerable cost savings. What is more, it is now also possible to machine difficult-to-cut

materials such as copper or brass. The laser machines the sheets fully automatically. The use of non-contact sensor technology ensures that the laser beam remains focused on the sheet, thereby guaranteeing high-quality and, most importantly, reliable cutting operations. Increased process reliability is possible thanks to a gap near the laser axis which allows cutting gas and slag to escape and ensures that machining can be performed without splashbacks. An automatic

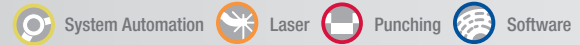

Optimum combination of punching and laser cutting: The FLCP-2515 AJ is always equipped with the right tool.



gas pressure control mechanism and fully automatic nozzle changer which operates without any need to interrupt processing are key elements that mean not only that the machine can run unattended for extended periods but also that a variety of machining steps are possible without manual intervention.

Precise and economical

The installed multifunction turret with its four thread tapping stations is not only remarkable

for its high tool capacity but also permits rapid tooling times and flexible production. The lifting brush table around the turret ensures the scratch-free, non-abrasive machining of the materials and eliminates the need for retouching work. By raising the level of the table, it is possible to prevent downward forms, in particular, from colliding with the die and thereby ensure trouble-free work-piece movement.

A further production benefit of the FLCP-2515 AJ comes from the fact that it supports various forms of automation. For example,

the machine possesses additional loading and unloading functions to permit integrated parts sorting. Overall, this new combination machine offers a higher level of economic efficiency. "The fact that the overall manufacturing times are significantly shorter and the cost of inputs such as electricity and gas are much lower means that the cost per part is greatly reduced," summarizes Axel Willuhn, Product Manager for Punching and Laser Technology at AMADA. ●



Short manufacturing times and low energy requirements cut production costs.

T E C H N I C A L D A T A

FLCP-2515 AJ

Punching force	200 kN
Punch drive	servoelectric
Fiber laser output	2,000 W
Working area	3,000 × 1,500 mm
Maximum material thickness	6 mm

ACIES-2515 T punch-laser combination system

Highly automated completion of complex tasks

When punching and laser processing are combined in one and the same machine, there is practically no limit to the range of production possibilities. How users can make the most of these possibilities is demonstrated by AMADA at the ACIES-2515 T with external tool changer.

There is one aspect of globalization that has permanently changed the range of demands placed on the sheet metal working industry: In many cases, the mass production of identical parts has been relocated to the so-called low-

wage countries. To compensate for this, many fabricators in the Western nations are focusing increasingly on production tasks that require in-depth technological expertise and the use of highly innovative machine technol-

ogies. This is the segment addressed by AMADA's punch-laser combination systems. The top end of this product range consists of the ACIES systems which are equipped with a CO₂ laser. This conventional laser technology has proved its value over many years thanks to its outstanding cutting quality. Together with the innovative fiber laser machines, the conventional laser systems help form a harmonious, wide-ranging portfolio which ensures that AMADA's

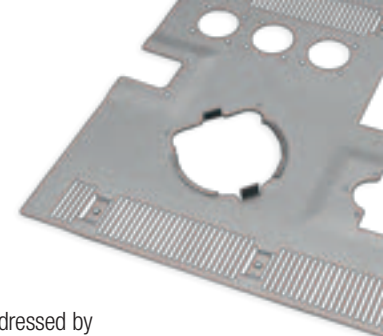

System Automation



Laser



Punching



Software



The automatic tool changing system ensures particularly efficient operation.

The system specializes in the manufacture of complex parts.

customers always receive the solution that is best suited to their tasks and applications from their machine supplier – with no compromises.

Sheet metal working companies have for some time been confronted with a further imperative: A very high level of automation is often necessary in order to ensure economic production. At EuroBLECH 2012, AMADA will demonstrate the ACIES-2515 T, a production cell that perfectly fulfills these two requirements – flexibility during the manufacturing process coupled with a high level of automation.

Intelligent management of tool configurations

“One outstanding feature of our new punch-laser combination is the interfacing with an external tool changer which satisfies all requirements,” stresses Axel Willuhn, Product Manager for Punching and Laser Technology at AMADA. “This permits the almost totally unattended manufacture of even complex components with frequently changing job specifications and small run sizes.” The TSU tool changing system can be equipped with up to several hundred punching tools. As

a result, and in combination with the extremely versatile laser machining capabilities, it is now extremely rare to be confronted with any production tasks that demand time-consuming machine tooling operations. To permit the efficient management of extensive tool configurations, AMADA has developed its Tool ID System. The intelligent thing about this system is that: the system always “knows” the status of all the tools in terms of size, shape, angle and stroke rate. This eliminates errors during setup. ●



T E C H N I C A L D A T A

ACIES-2515 T

Punching force	300 kN
Punch drive	servoelectric
Laser output	2,000 or 4,000 W
Working area	3,000 × 1,500 mm
Maximum material thickness	6 mm
Tool holders	32 or 36 stations
Automatic setup turret	32 or 43 stations
Automatic external TSU tool changing system	up to 404 stations

EM-3612 ZRT turret punch press

More quality – automatically

With the EM-3612 ZRT, AMADA is presenting a highly efficient turret punch press which permits the machining of large sheets without repositioning. This solution combines a very high process speed with an outstanding level of versatility and quality.

The EM-3612 ZRT represents an extension to AMADA's proven EM series in the form of a turret punch press that is able to machine large sheets without repositioning. The four thread tapping stations for sizes M2.5 to M8 that are integrated in the turret are automatically exchanged in the same way as the other

tools. At the same time, this new machine provides higher punching speeds. Just like the other machines in the EM series, the EM-3612 ZRT possesses a highly efficient servoelectric twin drive with energy recovery. The energy that is released when the ram is decelerated is stored and then re-used for

the next movement. In this way, the machine achieves extremely high stroke rates while simultaneously saving energy. With a punching force of 300 kN, the average energy requirement of the EM-3612 ZRT is between 4.5 and 5 kW. Taken together with the minimal maintenance costs and times, this provides significant savings.



System Automation



Punching



Software

EM-3612 ZRT turret punch press with servoelectric twin drive: Low energy requirement and minimal maintenance needs.

Ideal for large parts: The EM-3612 ZRT machines large sheets without repositioning.

Automatically smart

Alongside the tool turret itself, the machine also possesses a setup turret that can be equipped with tools during machine operation and feeds the tools into the turret as required. The constant reduction in required run sizes is placing ever greater demands on the punching sector. However, this solution makes it possible to cover all requirements and run complex jobs over a

period of several days without any manual intervention.

Thanks to the innovative TOOL ID, a barcode-based tool identification, the EM-3612 ZRT is able to access all the available tools and perform its own tool setups automatically. Due to this TOOL ID, the system can reliably detect the status of all the tools in terms of size, shape, angle and stroke rate. If necessary, it switches automatically to a replacement tool. Setup errors are eliminated and both waste

and costs are reduced. And there is another special feature: The lower turret level is fully covered by an intelligent brush table. Only the tool that is currently being used is raised to the operating level. This permits scratch-free machining and consequently secures a constantly high production quality. ●

T E C H N I C A L D A T A

EM-3612 ZRT

Punching force	300 kN
Punch drive	servoelectric
Working area	3,000 × 1,500 mm
Tool holders	32 or 36 stations
Automatic setup turret	32 or 43 stations
Automatic external TSU tool changing system	up to 404 stations



The intelligent brush table permits the reliable, scratch-free machining of the sheet.

AMADA HG series

The latest generation of press brakes

At EuroBLECH 2012, AMADA will present its new HG series of press brakes with servoelectric hybrid drives. In this series, the focus has been placed on outstanding precision, economic efficiency and ease of use – for high-end bending operations.

The HG series of machines is characterized by its exceptionally high level of productivity. This is due not only to the high operating speeds but also, and more importantly, to

various equipment features which guarantee continuous, top-class accuracy. The machines possess a high-precision press beam drive which ensures outstanding angular bending

accuracy. Precise, uniform bending is guaranteed along the entire length of the press beam.

Another technological highlight: The HG series is equipped with TDS, a system designed to detect the properties of the material. If deviations occur, for example because the material properties are modified following a change in the sheet metal feedstock, then these are automatically



 System Automation
  Bending
  Software

Precision is one of the most important advantages of the HG series. One of the focal points during development was ease of use.

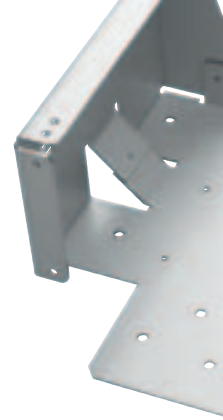

*For demanding bending operations:
The HG series is designed for high-end
production.*

compensated for by the intelligent
machine technology.

Economical and easy to use

Users can choose between two different
angle measurement systems: BI-S and BI-L.
The first of these uses tactile sensors to
measure the bending angle and makes
corrections as required. BI-L, in contrast,
is an optical system that works with laser
sensors. The same applies in both cases: The
system does not perform a post-machining

inspection; instead verification and correction
are performed directly during the bending
process. Ideally, this cuts material waste
and increases the economic efficiency of the
overall production process through time
savings and reduced material consumption.
Another factor guaranteeing the economic
efficiency of the HG series is the servo-
hydraulic hybrid drive. This requires less oil
than a purely hydraulic drive and maintenance
work is reduced. The extremely smooth-
running, low-noise operation is a further
advantage. In addition, the HG series of

machines are extremely easy to use. At
EuroBLECH 2012, two machines from the
HG series will be demonstrated live and, to
add just a bit more spice, one of these will
be equipped with an ATC automatic tool
changer (see article on page 28/29). ●

T E C H N I C A L D A T A

HG series

Press force	500 – 2,200 kN
Press beam length	1,400 – 4,280 mm
Installation height	520 mm (standard) 620 mm (long-stroke)
Stroke	250 mm (standard) 350 mm (long-stroke)
Distance between machine bases	1,030 – 3,760 mm
Overhang	450 mm
Press beam speed	220/20/250 mm/s
Adjustable backgauge	700 mm



*AMADA is introducing a full series
of HG press brakes.*

HG-1003 ATC press brake

With automatic tool changer for extremely small runs

Thanks to innovative technology, economic efficiency is possible in the sheet metal working industry irrespective of run sizes: At EuroBLECH 2012, AMADA will demonstrate how this is possible based on a practical application using one of the HG series of servo-hydraulic press brakes in combination with the ATC automatic tool changing system.

Even if not all machine users in the sheet metal working industry are confronted by this challenge, growing numbers of them are having to address it: The parts to be manufactured are becoming increasingly specific, the

number of parts variants is growing and run sizes are shrinking. Michael Groß, Product Manager for Bending Technology at AMADA GmbH, explains: "Feedback from our customers has confirmed that due to today's produc-

tion requirements, the proportion of time devoted to productive bending operations can sometimes be less than 50 percent. The remaining time is spent on machine set-ups. To overcome this problem, it is possible to equip the HG-1003 with the automatic ATC tool changer which has already made the HD-1003 a market success. This permits the economically efficient production even of tiny runs of under ten parts." ATC is a unique

 System Automation  Bending  Software



The automatic tool changer (to the right of the machine in the photo) makes the economically efficient manufacture of complex parts possible.



development with which AMADA is making pioneering strides on the global market. At the same time, AMADA has many years of experience with this technology – thanks to the tried-and-tested use of automatic tool changing systems in the ASTRO series of bending cells.

Not just for prototype manufacturers

At EuroBLECH 2012, AMADA will present the ATC automatic tool changer in combination with one of the new HG series of servohy-

draulic press brakes (see article on page 26/27). This type of production solution is intended for fabricators that frequently have to bend small parts runs as well as customers specializing in the manufacture of prototypes and samples. Furthermore, a press brake equipped with ATC represents an ideal extension to any existing machine pool and allows suppliers to complement their inhouse range with services catering for low-volume runs. The ATC offers outstanding versatility coupled with enormous capacity. The tool changing system possesses 18 magazines

for dies and 15 for punches. Each of these magazines can accommodate tools of up to 800 millimeters in length. The type HG-1003 ATC machine that will be presented at EuroBLECH 2012 will provide a vivid live demonstration of the advantages of the automatic tool changer in combination with the precision and ease of use of the HG series. Consequently, for example, the system is equipped with an electrically driven, travelling foot pedal which always moves to the press beam position where the operator will need it for the next bending operation. ●

T E C H N I C A L D A T A

HG-1003 ATC

Press force	1,000 kN
Press beam length	3,110 mm
Tool installation height	620 mm
Stroke	250 mm
Press beam speed	220/20/250 mm/s
Adjustable backgauge	700 mm
Distance between machine bases	2,740 mm
Overhang	450 mm



Ease of use is one of the advantages of the HG-1003 ATC.



EG-6013 servoelectric press brake

The small high-precision star

With a unique drive concept, AMADA is providing an impressive demonstration of how servoelectric press brakes can achieve peak precision and speed while simultaneously guaranteeing ease of maintenance. At EuroBLECH 2012, these capabilities will be presented at a type EG-6013 machine.

Top precision at extremely fast machining speeds – those were the aims behind the design of the EG-6013. Its area of application lies in the manufacture of small sheet metal

components which demand an outstanding level of production precision of the type required in large volumes by the electronics industry and which are integrated in a wide

range of end products. These include components that contribute to the inner workings of computers and cell phones as well as parts used in lamps or medtech devices. To meet the demands of its main target sector, the dimensions of this AMADA press brake with its fully electric drive were designed to be extremely compact. A maximum press beam length of 1,300 mm and seven controlled axes was the optimum value

 System Automation
  Bending
  Software



The EG-6013 with its 1,300 mm press beam length was specially designed for components that demand high-precision production.



to cover the machine's entire application scope. For fabricators, this is a financially important consideration because it is widely acknowledged not only that modern machines should excel through a high level of energy efficiency but also that low space requirements are another important cost factor.

The advantages of a dual drive

One of the EG-6013's outstanding features is its so-called DSP drive concept. This is a special design characteristic that only AMADA can

supply: A separate drive unit is mounted on either side of the press beam and each of these units consists of two motors. Two 3.0 kW units serve exclusively to apply the force required for the bending process while two 1.5 kW motors ensure the extremely fast approach and return strokes. Each of the two pairs of motors has also been optimized for a specific purpose within the cycle. This arrangement further increases the already outstanding response characteristics of servo-electric drives while providing a high level of process reliability. AMADA has many years of experience in the

construction of press brakes with fully electric drives. As a complement to the company's portfolio of hydraulic and hybrid presses, they are remarkable for their exceptional ease of maintenance and low environmental impact. Visitors to the AMADA booth at EuroBLECH 2012 will be able to experience the ergonomic benefits of the completely newly developed control unit with its three-dimensional graphical display first-hand at the EG-6013. In the same way as the presses of the HG series, the EG-6013 machine on display at the trade fair will be equipped with the TDS material detection system. ●

T E C H N I C A L D A T A

	EG-6013
Press force	600 kN
Press beam length	1,300 mm
Installation height	485 mm
Stroke	150 mm
Press beam speed	220/25/220 mm/s
Drive power, bending	2 × 3.0 kW
Drive power, approach	2 × 1.5 kW

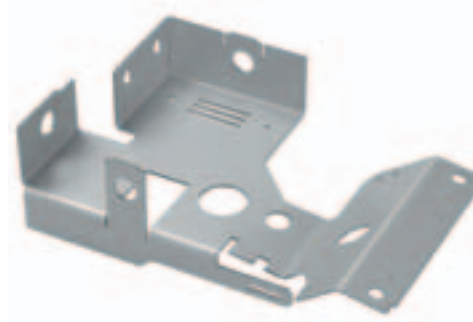

Complex parts and components represent a challenge that fabricators working with bending technology have to rise to.

EG-6013 AR automated bending cell

The robotic all-rounder

More than just loading and unloading: The many different tasks performed by the automatic robotic system within the EG-6013 AR bending cell are the most impressive feature of this system.

High-precision servoelectric press brakes can demonstrate their productivity benefits particularly efficiently when they are used in combination with a bending cell that possesses an equally efficient automation system. Based on its many years of experience of automated bending with the ASTRO series, AMADA has

developed a new bending cell which it intends to present at EuroBLECH 2012. The EG-6013 AR bending cell consists of the fully electric EG-6013 press brake (see article on page 30/31), a robot that moves along a ground travel path parallel to the machine and an automatic, high-capacity tool

changer. Together, these system components provide two particularly crucial advantages: outstanding precision and long unstaffed production runs in automatic mode.

Automation with flexible options

The automatic robotic system used in the EG-6013 AR is particularly versatile. The 6-axis robot moves along a ground travel path of 3.2 meters in length. In the bending cell,



 System Automation
  Bending
  Software

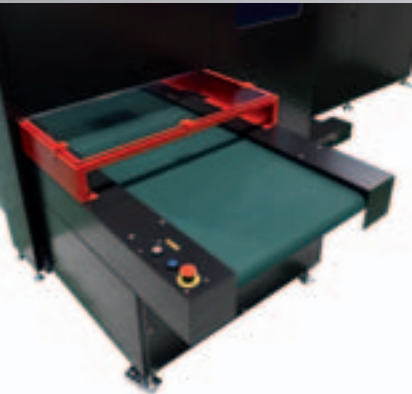

The robot moves along a ground travel path in front of the machine, loading and unloading are performed at different positions.

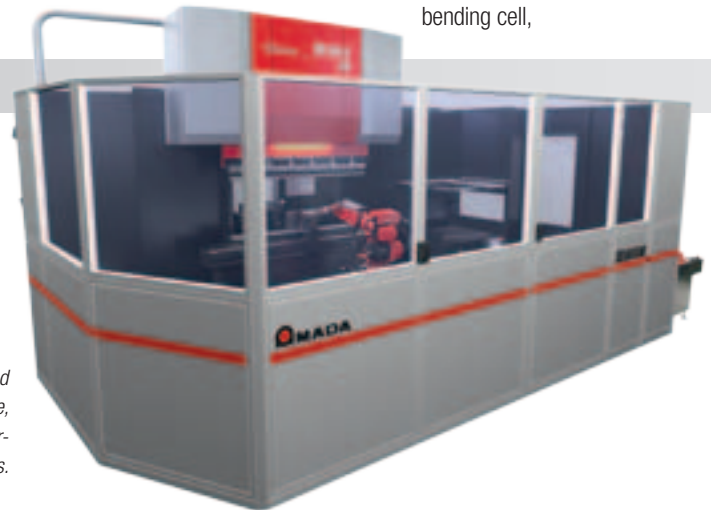



Parts like this one that cannot be stacked are placed in boxes or on a conveyor belt.

loading can be performed from four different positions. This means that there is considerable capacity for raw materials. The length of the ground travel path means that several different unloading options can be provided for simultaneously. The workpieces can be stacked or, if this is not possible, placed in boxes or on a synchronized conveyor belt. One truly impressive characteristic lies in the fact that the robot does much more than just load and unload: It changes both the bending

tools and its grippers itself and performs workpiece handling throughout the entire bending process across all the tool stations. It performs all tracking movements and also carries out process steps that cannot usually be achieved using manual operation. For example, the mechanical grippers can also be guided around the tools in the press's working area in order to ensure optimum assistance during operation tracking. The backgauge of the EG-6013 AR is

equipped with tactile sensors. These are innovative in their ability to detect the position of the workpiece in both the X and Y directions prior to bending and initiate corrective measures if departures from tolerances are identified. This system makes a further contribution to ensuring the maximum precision that is typically demanded for the small, complex parts that are manufactured in bending cells of this size. ●

T E C H N I C A L D A T A

EG-6013 AR

Press brake

Press force	600 kN
Press beam length	1,300 mm
Installation height	635 mm
Press beam speed	225/25/225 mm/s
Maximum part size	300 × 300 mm

Automation

Length of ground travel path	3,200 mm
Tool changer capacity	12 magazines each of tool length of up to 800 mm
Number of robot axes	6
Bearing load	10 kg



The newly developed control unit boasts an impressive, clear 3D graphical display.

BVD GmbH, Nedere Börde-Gersdorf, Germany

Looking to the future with fiber laser technology

Welded assemblies, components for wind power plants, letter boxes or waste bins for outdoor use – that is just a small selection from the wide-ranging portfolio of products and services offered by the company Blechverarbeitung Dahlenwarsleben GmbH, or BVD for short, which has its head office in the German town of Gersdorf in the state of Saxony-Anhalt. The company was the first in Europe to commission an AMADA fiber laser system.

Gersdorf, like Dahlenwarsleben from which AMADA's customer BVD gets its name, are both districts of the municipality of Nedere Börde which is situated close to the state capital Magdeburg. Ever since the company was founded in 1990, BVD's owners have relied on machines and systems from AMADA for their production activities. The latest addition to the company, which is managed by second-generation owner Annette Meffert, is an FOL-3015 AJ fiber laser system – the first of its type to be installed at an

AMADA customer in Europe. This fiber laser cutting system, which has been in operation since early 2012, represents a logical extension to the company's machine pool. "Fiber laser technology allows users such as BVD to achieve significant savings in resources," explains Michael Gülland who, as AMADA's Regional Sales Manager (Germany East), is responsible for supporting BVD GmbH. "This is due, on the one hand, to the lower power consumption compared to conventional CO₂ lasers and, on the other, to the reduced



maintenance requirements." What is more, the technology can be used to machine materials that cannot be processed using CO₂ lasers. These include copper, brass and titanium, even at high sheet thicknesses. The machining speeds achieved by the fiber laser helped win over the head of BVD, Annette Meffert. Because it is an established tradition in the company for the machines to have names, the FOL-3015 AJ is known internally as "Flea". Annette Meffert explains: "Naturally this has nothing to do with the size

BVD manufactures and ships complex parts in runs of all sizes exactly when its customers need them.



System Automation



Laser



Punching



Software



Shearing



Bending



Welding



of the machine. Actually, we call it that because the system is so swift.”

Bending technology for large components

One of the BVD's biggest heavyweights is “Popeye”, an AMADA HFP-2204 press brake, which works alongside its assistant “Olive Oyl”, an ABS R-165 handling robot. Together, they form a bending cell that is able to cope with large-sized, heavy components weighing

up to approximately 100 kg. “In the past, it took up to three employees to bend parts like that. We use this powerful, automated bending cell not to save on human labor requirements but instead to create better working conditions for our employees,” stresses Annette Meffert. In the same way as the fiber laser, the introduction of bending robot technology in 2011 represented a new forward-looking departure during which BVD GmbH was able to count on AMADA's technological support. ▶

In addition to laser cutting (top left) and bending, BVD is also expert in the field of punching technology (top).

*"Popeye" and "Olive Oyl":
The powerful HFP-2204
press brake is automated
using an equally high-
performance handling robot
and is able to machine
large components.*



I N F O

The company Blechverarbeitung Dahlenwarsleben GmbH was founded by Diether Dreilich, father of current Managing Director Annette Meffert. The founder, who died in 2007, showed great courage and foresight: He created this privately run business back in 1990, the year of German reunification, out of what had previously been a privatized company during the GDR era. The company already possessed decades of experience of sheet metal working. Instead, the great challenge consisted of constructing a modern production facility. Right from the outset, Diether Dreilich chose to rely on AMADA's machines. Now, there are 16 of them in operation at the BVD factory in Gersdorf. Annette Meffert manages a team of more than 30 employees and points, with justifiable pride, to their level of training which is extremely high, in particular for the eastern part of Germany.



T E C H N O L O G Y

Blechverarbeitung Dahlenwarsleben GmbH currently (autumn 2012) operates 16 AMADA systems representing various areas of machining technology. These include:

Laser technology	FOL-3015 AJ fiber laser system, LC-2415 ALPHA IV NT laser cutting machine
Bending technology	Automatic bending cell with HFP-2204 press brake and ABS R-165 handling robot, HFP-8025 press brake
Punching technology	2 EMZ-3510 NT servoelectric turret punch presses, each equipped with MP-3015 SheetCat loading and unloading systems, AC-255 NT servoelectric turret punch press

*BVD Managing Director
Annette Meffert has confidence
in AMADA technology and
commissioned a fiber laser
system.*

Worth it right from the start

Annette Meffert, Managing Director of Blechverarbeitung Dahlenwarsleben GmbH, commissioned Europe's first AMADA fiber laser system.

MARKER: You have been using fiber laser cutting technology since early 2012. What are your experiences of it so far?

Annette Meffert: The new technology proved its worth right from the start. It represents an extension to our production portfolio because we are now able to machine additional materials and can be more flexible in the material thicknesses we use. It's important to point out that we use fiber laser as a complement to conventional laser cutting. It was therefore not a question of replacing one technology with another. Instead, we have invested in extending our capacities.

MARKER: What was it that persuaded you to invest in innovative fiber laser technology?

Annette Meffert: I was very impressed by the speed of the system. I was able to experience this during a visit to a trade fair. The investment in the technology as well as in the capacity was something of a courageous step that has proved to be absolutely worthwhile.





MARKER: Why exactly?

Annette Meffert: Adherence to schedules and short delivery times are our formula for securing customer loyalty. Of course, these important factors are not due solely to the



new fiber laser system. Instead, we rely on a complete pool of AMADA machines including the exemplary services provided directly by the manufacturer. ●

A M A D A S E R V I C E

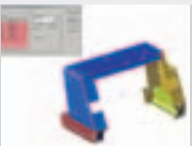
	Punching Machines Automatic Loading and Unloading Systems Phone +49 2104 2126-255 Fax +49 2104 2126-405 @ service@amada.de
	Press Brakes Shearing Machines Bending Robots Phone +49 2104 2126-268 Fax +49 2104 2126-405 @ service@amada.de
	Laser Cutting Systems Punch-Laser Combination Systems Phone +49 2104 2126-272 Fax +49 2104 2126-405 @ service@amada.de
	Sales of Spare Parts Tools Accessories Phone +49 2104 2126-211 (Germany) Phone +49 2104 2126-208 (Export) Fax +49 2104 2126-401 (Germany) Fax +49 2104 2126-402 (Export) @ werkzeuge@amada.de
	Software Phone +49 2104 2126-222 Fax +49 2104 2126-405 @ service@amada.de

In dialogue with AMADA

The world of high-end sheet metal working

The industry's most prestigious international trade fair, EuroBLECH 2012, which forms the focus of the current edition of MARKER, is not the only excellent opportunity to find out more about AMADA's world of high-end solutions. Other opportunities are available in the form of visits to the AMADA Solution Center, one of the Technical Centers, or at the many other trade fairs at which the company is represented.

The AMADA Group is one of the world's leading manufacturers of sheet metal working machines. It was founded in 1946 in Japan by Isamu Amada. The German subsidiary AMADA GmbH has been operating since 1973. AMADA offers a comprehensive range of cutting, bending, punching and laser tech-



Come and see us! AMADA GmbH welcomes its customers to its Solution Center in Haan near Düsseldorf.

nologies. The portfolio is complemented by modular automation components, software applications and a wide range of tools. In addition, the company provides its customers with a wide variety of additional services. AMADA's world of technology can be experienced at any time at company branches across the globe. Here, AMADA welcomes visitors in a very special atmosphere which clearly expresses its appreciation of its customers. ●



KEY DATES 2012 / 2013

2012

17.10. – 20.10.

TIB, Bucharest, Romania

23.10. – 27.10.

EuroBLECH, Hanover, Germany

20.11. – 28.11.

AMADA SOLUTION, Haan, Germany

2013

13.05. – 17.05.

Demo Metal Perioada, Bucharest, Romania

21.05. – 24.05.

International Engineering Trade Fair, Nitra, Slovakia

27.05. – 31.05.

Metalloobrabotka, Moscow, Russia

28.05.– 31.05.

Mach-Tech, Budapest, Hungary

04.06. – 07.06.

Mach-Tool, Poznań, Poland

16.09. – 21.09.

EMO, Hanover, Germany

07.10. – 11.10.

MSV, Brno, Czech Republic

05.11. – 08.11.

Blechexpo, Stuttgart, Germany

**Direct sales for Germany,
Austria, the Netherlands
and Romania:**

**AMADA GmbH
Amada Allee 1
42781 Haan, Germany**

**AMADA GmbH
Ottostraße 27
84030 Landshut, Germany**

From spring 2013:

**AMADA GmbH
Bichlmannstraße
84174 Eching/Landshut,
Germany**

**Phone: +49 2104 2126-0
Fax: +49 2104 2126-999
info@amada.de
www.amada.de**

Subsidiary in Russia:

000 AMADA
Ul. Dokukina, 16/3
129226 Moscow, Russia
Phone: +7495 518-9650
Fax: +7495 518-9651
info@amada.ru
www.amada.ru

**AMADA GmbH export
representatives:**

Poland
ABH Biuro Techniczne
ul. Swierszcza 78/80
02-401 Warszawa, Poland
Phone: +48 22 863-5980
Fax: +48 22 863-4397
info@abh.com.pl

Czech Republic
STEMA-TECH spol s.r.o.
Svatopetrská 7
61700 Brno, Czech Republic
Phone: +420 5 47217364
Fax: +420 5 47227090
stematech@stematech.cz

Slovakian Republic
AMZ Slovakia, s.r.o.
Nám. A. Hlinku 26
01701 Považská Bystrica,
Slovakian Republic
Phone: +421 42 4260849
Fax: +421 42 4260850
amada@amada.sk

Hungary
EPL-TECH Kft.
Basa u. 4.
8000 Székesfehérvár, Hungary
Phone: +36 22 315-668
Fax: +36 22 315-668
info@epl-tech.hu

Bulgaria
VEMAN Ltd.
82, Christo Botev blvd
4000 Plovdiv, Bulgaria
Phone: +359 32 633548
Fax: +359 888 701438
info@veman.biz

Ukraine
Batex Ltd.
Timiryazevskaya Str. 2
01014 Kiev, Ukraine
Phone: +380 44 2865757
Fax: +380 44 2867556
ai@batex.com

Belarus
Rominex GmbH
Pr. Pobeditelej, 14/61
220035 Minsk, Belarus
Phone: + 375 17 5022896
Fax: + 375 17 5022897
rominex@rominex.by
rominex@inbox.ru

IMPRINT

MARKER is a magazine published periodically by AMADA GmbH for its customers, potential customers and employees. Due to technological advances, technical, dimensional, design and equipment changes may be made without notice.

Responsible:

Nicole Goldhorn,
Anne Frankenheim
AMADA GmbH, Amada Allee 1
42781 Haan, Germany
Phone +492104 2126-0
Fax +4921042126-999
info@amada.de
www.amada.de

Published by:

mk publishing GmbH
Döllgaststraße 7–9
86199 Augsburg, Germany
Phone +49 821 34457-0
Fax +49 821 34457-19
info@mkpublishing.de
www.mkpublishing.de

Photo credits: AMADA, Stefan Durstewitz, Fotolia/Frank Peters/visdia, Mack Brooks Exhibitions, mk publishing/mk archive